

Please be aware of the following points before using the TGE Group MP317 MP3 PRO.

Copyright© 2006, TGE Group. All rights reserved. Windows NT[®], Windows 2000[®], Windows ME[®], and Windows XP[®] are registered trademarks of Microsoft Inc. Apple[®] and Macintosh[®] are registered trademarks of Apple Computer Inc. IBM and OS/2 are registered trademarks of the International Business Machines Corporation. All other brand or product names are trademarks of their respective companies or organizations.

TGE Group will not be held responsible for any illegal use of this product nor any losses incurred while using this product. The user is responsible for the copyright laws, and is fully responsible for any illegal actions taken.

CUSTOMER SERVICE

To obtain service or technical support for your system, please contact TGE Group Technical Support Department at tech.support@tgegrou.com

TGE Group

www.tgegrou.com

Quick-Trans™

Quick-Trans™ technology is proprietary software that has been patented by TGE. **Only TGE MP3 players** have this unique software built in. Quick-Trans™ can transfer CD songs from the users Music-CD into MP3 formatted songs and store them in the MP3 Player. The transfer of music from the CD to MP3 player should only take seconds. **No** downloading onto the hard drive is necessary. Users can make CD transfers by doing the following:

First Step:

Insert the Music CD disk into the computers CD drive, then connect the MP3 player to computers **USB** port. After the computer finds the device, a flashing picture will appear in the middle of the screen as illustrated in the following figure:

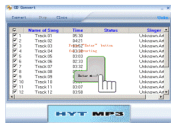

Second Step:

After the prompting picture appears, users can start the CD transfer by pressing the “Enter” button of the computer. Then the progressing bar will appear as illustrated in the following figure to indicate the progress of the CD transferring.

<input checked="" type="checkbox"/>	4	ascagni: sancta maria	03:38	100%	Andrea Bocelli
<input checked="" type="checkbox"/>	5	Gounod: ave maria	03:03	100%	Andrea Bocelli
<input type="checkbox"/>	6	Schubert: ave maria	02:33		Andrea Bocelli
<input checked="" type="checkbox"/>	7	Wagner: parsifal: kundry's aria	03:32	100%	Andrea Bocelli
<input type="checkbox"/>	8	Vivaldi: g.ROSSINI: cuius animam	05:36		Andrea Bocelli
<input checked="" type="checkbox"/>	9	Verdi: ingenuo	04:12	<div style="width: 13%;"><div style="width: 13%;"></div></div> 13%	Andrea Bocelli

Explanation:

Most people have music CDs at home and would like to have that music on their MP3 players. Now **Quick-Trans™** gives them the opportunity to transfer this music with minimum effort. You will also find that the sound quality of music transferred from a CD is much better than music that is downloaded.

1. The **Quick-Trans™** program will store the transferred songs in the folder name of the CD album and song name of Track xx mp3 from the CD in the MP3 Player directly, (xx range is from 01 to 99, representing the number of songs).
2. Digits 1-16" will appear above the **Quick-Trans™** progress bar, which represents the number of transferred songs.
3. Users can click the "Cancel" button to stop the process of transferring songs.
4. Prompting pictures will appear again by double clicking the **left** button of mouse on the **Quick-Trans™** icon in the system tray program.
5. Users can also start the CD transfer by clicking the icon on the **Quick-Trans™** program in the system tray.
6. Click the **right** button of the mouse on the icon in the **Quick-Trans™** program and select "transfer" to start transferring the music from the CD.
7. Exit the **Quick-Trans™** Program by clicking "Exit".
8. The program will run when the switch button is in the "**ON**" position, The program will stop when the switch button is in the "**OFF**" position.

TABLE OF CONTENTS

WELCOME.....	6
TECHNICAL SPECIFICATION.....	7
PACKAGE CONTENTS.....	8
QUICK START.....	9
OPERATION NOTES.....	10
PLAYER CONTROLS.....	11
FRONT VIEW.....	11
SIDE VIEW.....	12
LCD.....	13
TURNING THE POWER ON/OFF.....	14
PLAYING MP3 MUSIC.....	15
VOLUME CONTROL.....	16
MENU MODE.....	17
VOICE RECORDING FUNCTION.....	18
SETTINGS: EQ(EQUALIZER).....	19

SETTINGS:REPEAT.....	20
SETTINGS:LCD CONTRAST.....	22
SETTINGS:AUTO OFF TIME.....	23
SETTINGS:REC SAMPLE.....	24
FM RADIO.....	25
BUILT-IN FM REC FUNCTION.....	26
DELETING FILES.....	27
REPEAT A-B MODE.....	28
MEMORY STATUS.....	29
CONNECTING TO YOUR PC.....	30
DISCLAIMER.....	31
WARRANTY.....	32
TECH SURPPORT.....	32

Welcome

The TGE Group MP3 Player is a high quality, portable USB flash drive AND MP3/WMA Player rolled into one! Store and play all your favorite digital music as well as Word, PowerPoint or any other file you need while on the go. The TGE Group MP3 Player will play all files with an MP3 or WMA extension! Plug this mini MP3 player directly into any USB port for quick, easy access! Simply drag and drop or save your files directly to the drive! The TGE Group MP3 Player will work with Windows, Macintosh and Linux, and is driverless with most Operating Systems. With one AAA battery, you can take advantage of 12 hours non-stop playing time.

Technical Specifications

- Supports USB specification version 2.0
- Transferring rate up to 12Mbit per second at “Full Speed”.
- Supports Windows 2000, ME, XP, Mac OS 9.2 or above and Linux 2.4.0 or above without device driver.
- Key lock / write protect switch.
- Hot Plug & Play.
- Durable solid-state storage – data retention for at least 10 years.
- Erase Cycles: 100,000 times
- Support music format: MP3 / WMA
- LCD Display: 96x32 Dot Matrix
- Earphone jack: 3.5 mm
- Audio output: 5mW + 5mW
- Output frequency range: 20Hz – 20KHz
- Battery Life: 12 hrs of continuous playback
- EQ choices: Normal / Rock / Classic / POP / Jazz
- ID3 Tag Display
- Digital voice record in ADPCM 8kbps
- Repeat read function (A - B).
- Unit weight: approximate 30g (not including battery)
- Bit Rates Supported: Supports 8Kbps ~ 256Kbps
- S/N Ration: 85dB~90dB
- Size: 99 x 31 x 22 mm
- CE and FCC certificate of approval

Package Contents



USB Cable



Stereo Earphones

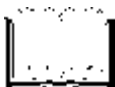

Manual



AAA Battery

Quick Start

Please note, the following instructions are intended to give you a brief overview, allowing you to use the player right away.

1. Remove the back cover and insert the AAA battery.
2. Connect the drive to an available USB port on your PC and the unit will appear as a “Removable Disk” under “My Computer”.
3. Double click on the “Removable Disk” icon to view its contents. To load audio files, simply save the desired MP3/WMA file to this drive.
4. Remove the drive from the USB port, and press the Play button to turn on the power.
5. Insert the headphones, and press the Play button again to begin audio playback. Use the Mode scroll wheel on the side of the unit to navigate through audio tracks.

Operational Notes

1. Please remove the battery if you do not plan to use the MP3 player for extended periods of time.
2. The MP3 player should be kept in areas free from extreme temperature changes, moisture, and dust.
3. The MP3 player cannot be turned on if the HOLD switch is in the ON position.
4. Please change the battery when the indicator  appears and “Low Battery” is displayed.
5. The Mode/FF/RW button on the side of the player can be scrolled to the left or right and also pushed to make selections in the menus.

Player Controls

Front View

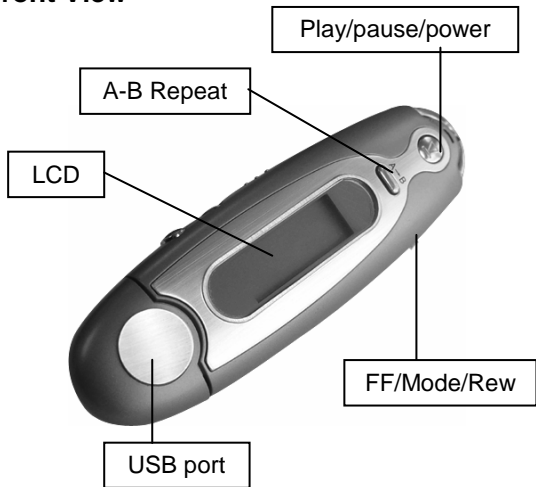

Side View

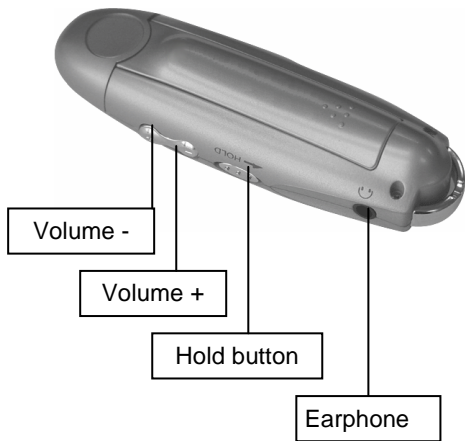

LCD

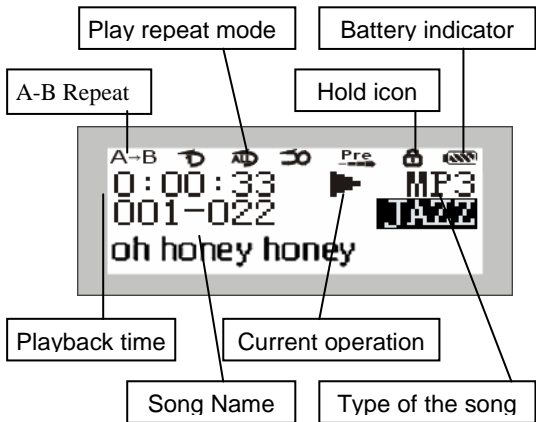

Repeat modes: Repeat, Repeat All, Random, Preview and Normal.

Equalizer modes: Jazz, Classic, Rock, Pop and Normal.

Turning the power on/off

To turn on the MP3 player, press and hold the PLAY button for 2 seconds. “TGE Mp3 Player” will be displayed on the LCD screen.

To turn off the MP3 player, press and hold the PLAY button for 2 seconds. “Shut Down” will be displayed on the LCD screen.



Playing MP3 music

1. Turning on the power by pressing Play/Stop button momentarily, you could see the following interface:



The 001-022 means there are 22 songs loaded on this particular MP3 player, and it's currently on song

2. When you press Play/Stop button again, the current track will be played as shown above. The top left corner is the playback time indicator.

3. If you want to select previous/next song, turn the rolling wheel up and down to get the track. The music will stop if you press Play/Stop.

4. By pressing the Play/Stop button for 3 seconds, you can turn the power off.

Volume Control

The volume steps (see illustration) will increase or decrease when the VOL+/VOL- button is pressed correspondingly. There are 32 volume steps and the volume level ranges from 0 to 31.



Volume

Menu Mode

1. To enter the Menu mode, press down on the Mode button (in the middle of the rolling wheel). The LCD will display the following:

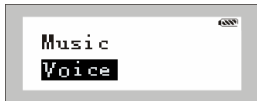

Here are the 7 options available to select from:

Music	Enter Music Mode
Record	Enter Record Mode
Settings	Set Parameter
FM Tuner	Enter FM Mode
Folder	Enter Folder Mode
Information	Show the memory info
Version	Show the S/F info
Exit	Return

2. To select an option, use the FF/RW wheel to scroll to the desired option. Then press down on the Mode button to enter that selection. Each screen has a Return option as the last item, which

can be used to return to the previous screen.

Voice Recording Function

There are two ways you can enter the Voice Recording function.

1. Press down on the Mode button to enter the Menu Mode, and scroll to the Record function. Press down on the mode button to begin recording. (See illustration).

2. Or you can press down on the A-B button for three seconds and it will begin to record immediately.

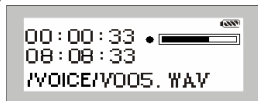

3. To stop recording, simply press the Play button. The .wav files can now be played back in the same manner as MP3 files.



Settings: EQ (Equalizer)

There are 5 Equalizer modes to select from: Jazz, Classic, Rock, Pop, and Normal.

1. Enter the **Mode Menu** and select the **Settings** option.
2. Select the **EQ** (Equalizer) option.
3. Scroll to the desired EQ setting (Jazz, Classic, Rock, Pop, or Normal) and press down on the Mode button to select that setting.



4. After selecting the EQ setting you will be returned to the Settings menu where you can return to the Main Menu.

5 The EQ setting will appear in the LCD, as show below.



Settings: Repeat

You can adjust the way files are played on your MP3 player to one of 5 modes:

Normal: Plays the MP3s in order and stops after the last file has been played. This is the default playback setting.

Preview: Plays the first 10 seconds of all MP3s in order and stops after the last file has been played.

Repeat Track: Plays the current MP3 file repeatedly.

Repeat All: Plays all MP3s in order repeatedly until another operation is performed.

Shuffle: Plays all MP3s at random and then stops.

To change the playback setting, please follow these steps:

1. Enter the **Mode Menu** and select the **Settings** option.
2. Select the **REPEAT** option.
3. Scroll to the desired REPEAT setting (Normal, Preview, Repeat Track, Repeat All, or Shuffle) and

press down on the Mode button to select that setting. (shown in illustrations)

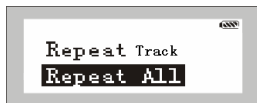

Repeat Track



Repeat All



Shuffle



Normal

Settings: LCD contrast

You can adjust the contrast of the LCD screen to work best in your surrounding environment.

1. Enter the **Mode Menu** and enter the **Settings** option.
2. Select the **LCD Contrast** option.
3. Scroll to the desired REPEAT setting. You can now adjust the contrast level by using the FF/RW scroll wheel as show below.



The LCD contrast can be adjusted from 0 to 11. Adjust the level according to the surrounding environment.

Settings: Auto OFF time

You can use this setting to automatically shut down the unit after a selected period of idle time.

1. Enter the **Mode Menu** and select the **Settings** option.
2. Select the **Auto OFF** option.
3. Scroll to the desired Auto OFF setting (Disable, 1Min, 2Min, 5Min, or 10Min).



If you select the “Disable” option, then your player will not shut down automatically during idle periods.

If you select one of the 4 time periods, then your player will automatically shut down after it's been idle for the selected amount of time.

Settings: Rec setting

You adjust the record setting of your voice recordings to improve the playback quality. Please note that recording at higher sample rates increases the file size of the recording. To change the recording quality, please do the following:

1. Enter the **Mode Menu** and select the **Settings** option.
2. Select the **Rec** setting option.
3. Scroll to the desired Rec quality setting Low, Middle, High.

FM Radio

Using the FM radio

1. Enter the Main menu, and dial the Mode button to choose "FM Mode".
2. Enter the "FM Mode" by pressing the Mode button.
3. Auto scanning: by holding the Last/Next button for 2 seconds, the player will search radio channels forward or backward by 100KHz frequencies, and automatically stop when it find a channel. If you want to stop scanning manually, just dial the Last/Next button.
4. Manual scanning: dial the Last button once and the frequency will decrease by 100KHz; dial the Next button once and the frequency will increase by 100KHz.
5. Save the found channels: enter the FM submenu by pressing the Mode button, and another press on the Mode button will save the channel.
6. Select and tune in the saved channels: if there are more than one pre-saved channel, you can navigate through them forward by pressing the Play button.
7. Control sound volume:
VOL+ to increase volume and VOL- to decrease volume

8. You can select between “Normal Frequency Range” (FM 87-108MHz) and “Japanese Frequency Range” (FM 76-90MHz) in different regions. (Enter the FM submenu by pressing the Mode button, dial the Next button, and choose the proper frequency range.)
9. If it is a stereo channel, the LCD will display the icon.
10. Up to 20 channels can be saved in both “Normal Frequency Range” and “Japanese Frequency Range”.
11. To delete channels, please refer to the “Delete Files” section.

Built-in FM Record Function

In FM tuning status, enter the FM submenu by pressing the Mode button.

Dial the Next button to page down.

Enter the Record interface by pressing the Mode button, and start high-quality voice recording. Save the record by pressing the Mode button, and exit to the FM interface.

Deleting Files

You can delete files from your MP3 player in 3 different ways:

1. Directly from the player.
2. Use Windows Explorer.

To delete files directly from the player, please follow these steps:

1. Enter the **Mode Menu** and select the Folders option.
2. Select the type of file to delete: **Music or Voice**.
3. After selecting the file type the first file in that category will appear on the LCD. You will have the option to save or delete this file by press the menu button.
4. Select YES to delete the file, or NO to save it and move the next file on the player.
5. If you do not want to delete any of the files you can hold down the Mode button for 3 seconds to return to the main screen.

Repeat A-B Mode

The MP3 player has a built in feature that allows you to repeat a certain part of an audio track. This can be a useful tool for things such as language learning or memorization. Please follow these steps to repeat a portion of a file:

1. Play the desired track. When you reach the section you want to repeat; press the **A-B** button to mark the beginning of the section. (shown below).
2. Continue playing the track until you reach the end of the section you want repeated. Press the **A-B** button to mark the end of the section. (shown below). Now you can repeat the selected part (A-B) of the track continuously by pressing play.

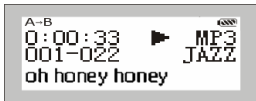

To cancel the function or move on to the next track, select the “Repeat A-B” function again or adjust the rolling wheel to reach the next designated track.

Memory Status

You could examine the memory usage of the MP3 player without being connected to the PC.

1. Enter the **Mode Menu** and select the **Memory Info** option.
2. The internal memory info will be displayed on the LCD screen showing the total capacity as well as the amount of free memory. (shown below)

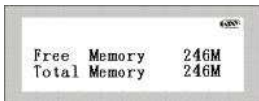
A screenshot of an MP3 player's LCD screen. The screen is rectangular with a grey border. In the top right corner, there is a small logo that says "GPO". The main display area shows two lines of text in a monospaced font. The first line reads "Free Memory 246M" and the second line reads "Total Memory 246M".

Free	Memory	246M
Total	Memory	246M

Connecting to your PC

To load audio files or data onto your MP3 player you must connect the drive to a PC. To transfer files to your MP3 player, please follow these steps:

1. Connect the MP3 player to an available USB port on your PC.

2. Your OS will recognize the player as a Removable Drive and it will assign the next available drive letter to the drive. The drive can be accessed in the same manner as any other drive through Windows Explorer.

3. The LCD on the player will display a “connection” picture if the connection successful. (shown below)

4. You can now transfer audio files to this drive manually.



Disclaimer

All the information in this document is subject to change without prior notice. The manufacturer does not make any representations or any warranties (implied or otherwise) regarding the accuracy and completeness of this document and shall in no event be liable for any loss of profit or any other commercial damage, including but not limited to special, incidental, consequential, or other damages.

No part of this document may be reproduced or transmitted in any form by any means without the express written permission of the manufacturer.

All brand names and product names used in this document are trademarks or registered trademarks of their respective holders.

Warranty

This product carries a 90 day limited warranty from the date of purchase.

Tech Support

If you experience any problems installing your TGE Group MP317 MP3 Player or have any technical questions regarding any of our products, please contact our tech support department at

tech.support@tgroup.com.

Our tech support is free and available Monday thru Friday.